

MKD1000 Series

MKD1096

▶ 90° x 60°

MKD1026

▶ 120° x 60°

MKD1064

▶ 60° x 45°

2-Way Full-Range Loudspeakers

- ▶ High output passive or bi-amplified two-way performance
- ▶ QX inspired 4in voice coil compression driver with extended bandwidth
- ▶ Precision EAW signature broadband pattern control
- ▶ Flexible mounting, weather protection, color and transformer options



OVERVIEW

The MKD installation loudspeaker series is engineered to deliver the high output, broadband pattern control and exceptional fidelity that is required by real-world applications from stadiums to intimate music clubs.

MKD builds on EAW's long standing tradition of exceptional installation focused loudspeakers developed in partnership with consultants and sound system integrators worldwide. The compact durable Baltic birch enclosure provides for easy installation with an array of M10 mounting points and optional wall-mount or ceiling-mount brackets. MKD also offers weather protection options, custom colors, and a gently curved front allow for concealed installations in the most visually sensitive environments.

MKD leverages the design tenets and core technologies deployed in our QX series by deploying a pair of spaced low frequency transducers centered around a large format rotatable horn. The acoustically advanced transducers are able to be driven an octave lower than standard drivers through the use of our beamwidth matched crossover technology.

INSIDE EAW TECHNOLOGIES

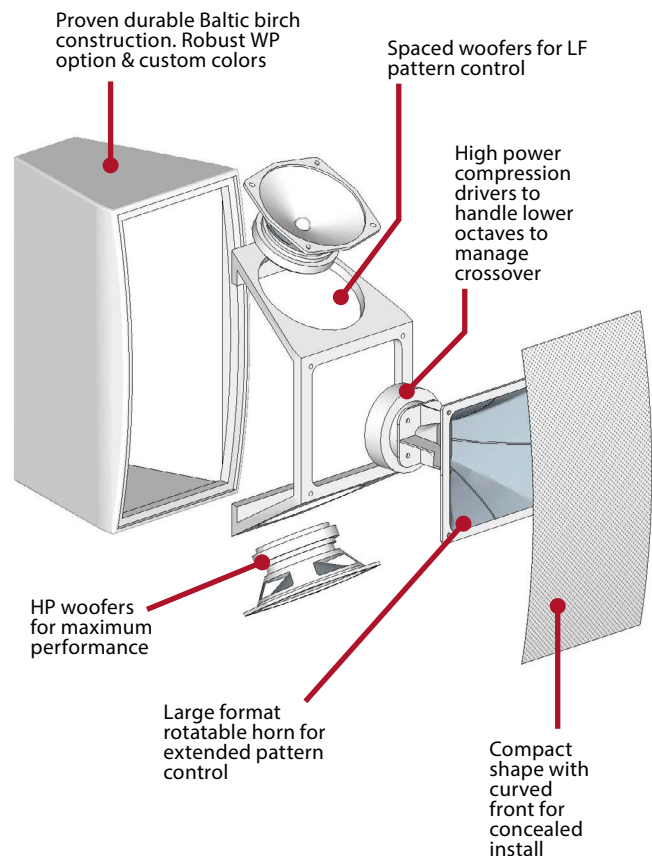

RECOMMENDED AMPLIFIER CONFIGURATION

PASSIVE

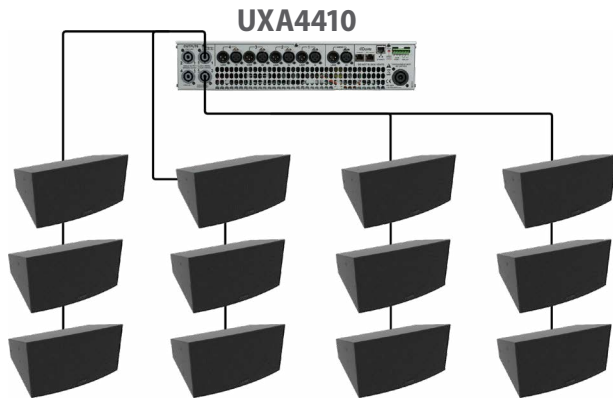

BI-AMP

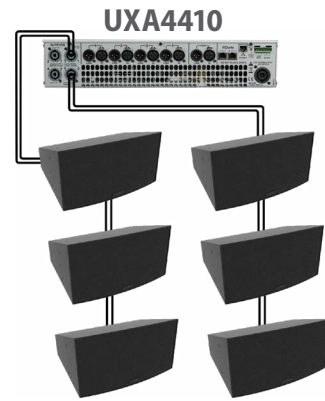

MODEL	PER CHANNEL	PER AMPLIFIER
UXA4810	1	8
UXA4406	2	8
UXA4410	3	12

EAW strongly recommends utilizing the processing setting to take full advantage of your speakers. Pair with EAW UXA Amps for the best performance of EAW Core Technologies



DynO



Focusing

Recommended 3rd Party Power Amplifier

- ▶ 800-1200 W @ 8 ohms

Third-Party DSP Support

- ▶ BSS
- ▶ QSYS
- ▶ Crown DCi Series
- ▶ Powersoft

RIGGING CONFIGURATION

Numerous M10 points for flexible mounting



MOUNTING HARDWARE

EAW

DESCRIPTION	PART NUMBER
U-Bracket Kit	Coming Soon
M10 Kit	0028272 [PA-A2 EYEBOLT KIT (4 PER)]

THIRD-PARTY COMPATIBLE

BRAND	MODEL
Adaptive Technologies	MM-120
Polar Focus	QX Mounting System

TECHNICAL SPECIFICATIONS

2-WAY FULL-RANGE LOUDSPEAKERS

PERFORMANCE	MKD1096	MKD1026	MKD1064
Max SPL ¹	142dB	141dB	144dB
Operating Range ²	57Hz - 20kHz		
Nominal Beamwidth ³	90° Horizontal x 60° Vertical	120° Horizontal x 60° Vertical	60° Horizontal x 45° Vertical
Nominal Phase	±15° from ideal high-pass filter		
Input Impedance	LF=8Ω HF=8Ω LF/HF=8Ω		
CONFIGURATION			
LF Transducer, Loading	2 x 10in Cone, 2.5in Voice Coil, Vented		
HF Transducer, Loading	1 x 1.4in Exit, 4in Neodymium Compression Driver, Horn Loaded		
Operating Modes	Passive, Bi-Amp		
PHYSICAL			
Physical/Rigging	12 x M10 Mounting Points		
Dimensions (HxWxD)	26.7 H x 14.6 W x 16.5in D (680 H x 370 W x 420mm D)		
Net Weight	60 lbs / 27.3 kg		
Shipping Weight	70 lbs / 31.8kg		
Mounting Accessories	U-Bracket, M10 Kit		
Input Connector	Terminal block		
ORDERING	MKD1096	MKD1026	MKD1064
Part Numbers			
<i>Black</i>	2070470-90	2070483-90	2070484-90
<i>White</i>	2070510-90	2070511-90	2070512-90
<i>WP (black only)</i>	2070513-90	2070514-90	2070515-90
Accessories			
<i>M10 Kit</i>	0028272 [4 PER]		
<i>U-Bracket Kit</i>	Coming Soon		

1 Calculated max SPL at 1m with 4:1 (12dB) crest factor pink noise. Specified as whole space (free field) for full range loudspeakers, half space for subwoofers.

2 Operating Range: Range where the processed Frequency Response stays within -10 dB SPL of the power averaged SPL within this range; measured on the geometric axis. Narrow band dips are excepted.

3 Nominal Beamwidth: Design angle for the -6 dB SPL points, referenced to 0 dB SPL as the highest level.

PERFORMANCE GRAPHS

PHASE LINEARITY

MKD1096

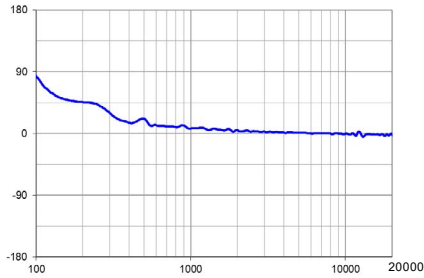

MKD1026

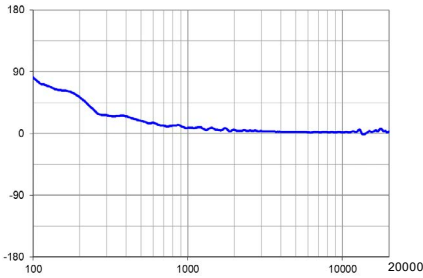

MKD1064

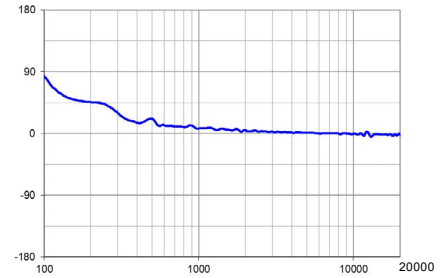

BEAMWIDTH ■=Vertical ■=Horizontal

MKD1096

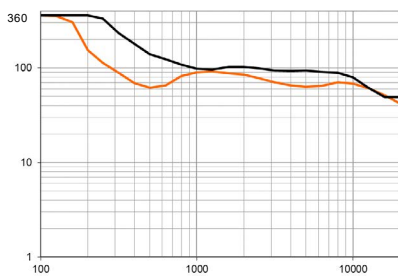

MKD1026

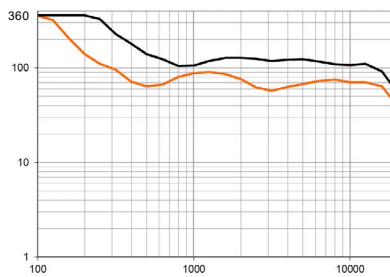

MKD1064

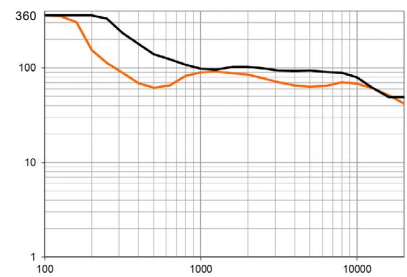

FREQUENCY ■=LF Processed ■=HF Processed ■=Overall Response Processed

MKD1096

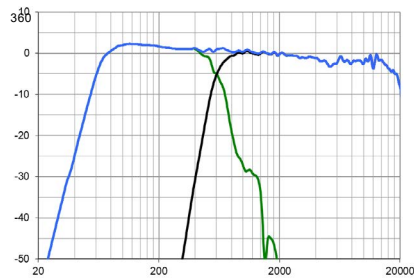

MKD1026

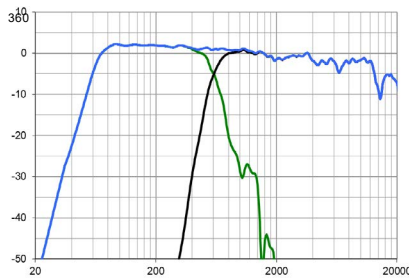

MKD1064

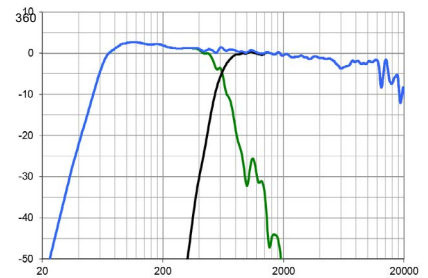

One Main Street
Whitinsville, MA 01588
Tel 800 992 5013 / +1 508 234 6158

www.eaw.com

