

MKD1200 Series

3-Way Full-Range Loudspeakers

- ▶ High output passive or bi-amplified three-way performance
- ▶ QX inspired coaxial compression driver with extended bandwidth
- ▶ Precision EAW signature broadband pattern control
- ▶ Flexible mounting, weather protection, color and transformer options

MKD1294

▶ 90° x 45°

MKD1264

▶ 60° x 45°



OVERVIEW

The MKD installation loudspeaker series is engineered to deliver the high output, broadband pattern control and exceptional fidelity that is required by real-world applications from stadiums to intimate music clubs.

MKD builds on EAW's long standing tradition of exceptional installation focused loudspeakers developed in partnership with consultants and sound system integrators worldwide. The compact durable Baltic birch enclosure provides for easy installation with an array of M10 mounting points and optional wall-mount or ceiling-mount brackets. MKD also offers weather protection options, custom colors, and a gently curved front allow for concealed installations in the most visually sensitive environments.

MKD leverages the design tenets and core technologies deployed in our QX series by deploying a pair of spaced low frequency transducers centered around a large format rotatable horn. The acoustically advanced transducers are able to be driven an octave lower than standard drivers through the use of our beamwidth matched crossover technology.

INSIDE EAW TECHNOLOGIES

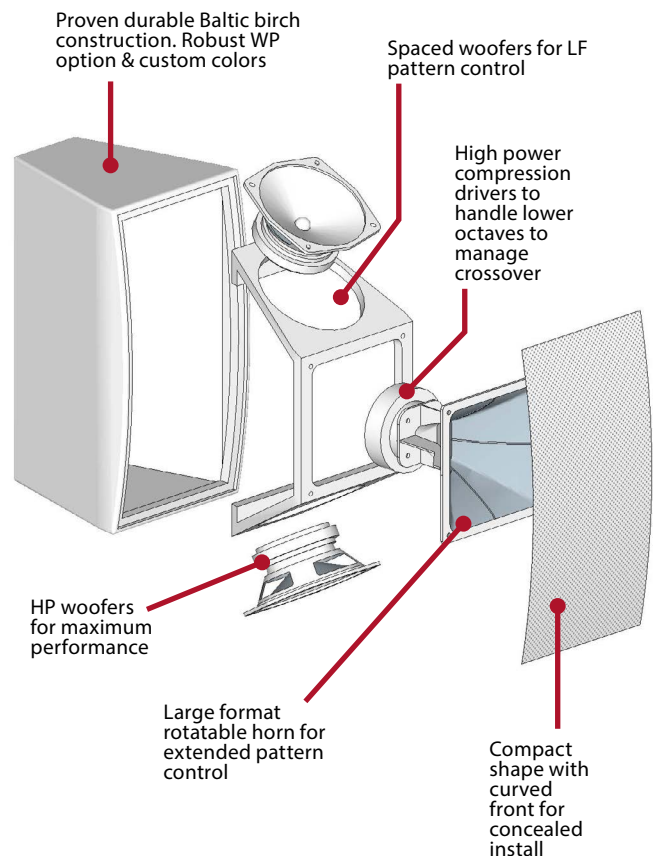

RECOMMENDED AMPLIFIER CONFIGURATION

PASSIVE

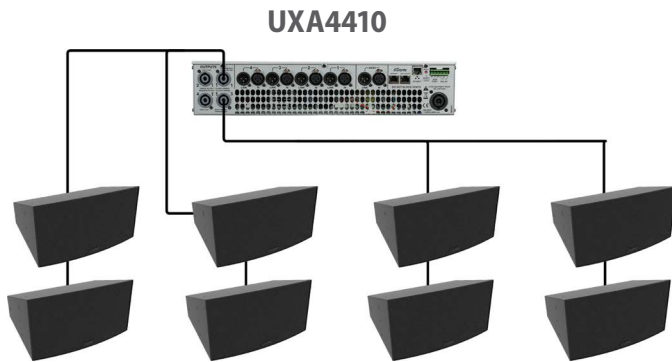

BI-AMP

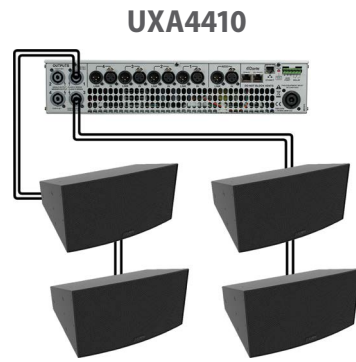

MODEL	PER CHANNEL	PER AMPLIFIER
UXA4810	1	8
UXA4406	1	4
UXA4410	2	8

EAW strongly recommends utilizing the processing setting to take full advantage of your speakers. Pair with EAW UXA Amps for the best performance of EAW Core Technologies



DynO



Focusing

Recommended 3rd Party Power Amplifier

- ▶ 1000-1500 W @ 4 ohms

Third-Party DSP Support

- ▶ BSS
- ▶ QSYS
- ▶ Crown DCi Series
- ▶ Powersoft

RIGGING CONFIGURATION

Numerous M10 points for flexible mounting



MOUNTING HARDWARE

EAW

DESCRIPTION	PART NUMBER
M10 Kit	0028272 [PA-A2 EYEBOLT KIT (4 PER)]
U-Bracket Kit	Coming Soon

THIRD-PARTY COMPATIBLE

BRAND	MODEL
Adaptive Technologies	MM-120
Polar Focus	QX Mounting System

TECHNICAL SPECIFICATIONS

3-WAY FULL-RANGE LOUDSPEAKER

PERFORMANCE	MKD1294	MKD1264
Max SPL ¹	145dB	147dB
Operating Range ²	47Hz - 20kHz	
Nominal Beamwidth ³	90° Horizontal x 45° Vertical	60° Horizontal x 45° Vertical
Nominal Phase	±15° from ideal high-pass filter	
Input Impedance	LF=8Ω HF=8Ω LF/HF=8Ω	
CONFIGURATION	MKD1294	MKD1264
LF Transducer, Loading	2 x 12in Cone, 3in Voice Coil, Vented	
MF Transducer, Loading	1 x 2in Exit, 3.5in Voice Coil, Compression Midrange, Horn Loaded	
HF Transducer, Loading	1 x 2in Exit, 1.75in Voice Coil, Compression driver, Horn Loaded	
Operating Modes	Passive, Bi-Amp	
PHYSICAL	MKD1294	MKD1264
Physical/Rigging	12 x M10 Mounting Points	
Dimensions (HxWxD)	32 H x 20.5 W x 20.9in D (813 H x 520 W x 530mm D)	
Net Weight	114 lbs / 52 kg	
Shipping Weight	125 lbs / 57 kg	
Mounting Accessories	U-Bracket, M10 Kit	
Input Connector	Terminal block	
ORDERING	MKD1294	MKD1264
Part Numbers		
<i>Black</i>	2070516-90	2070520-90
<i>White</i>	2070519-90	2070537-90
<i>WP</i>	2070524-90	2070531-90
Accessories		
<i>M10 Kit</i>	0028272 [4 PER]	
<i>U-Bracket Kit</i>	Coming Soon	

1 Calculated max SPL at 1m with 4:1 (12dB) crest factor pink noise. Specified as whole space (free field) for full range loudspeakers, half space for subwoofers.

2 Operating Range: Range where the processed Frequency Response stays within -10 dB SPL of the power averaged SPL within this range; measured on the geometric axis. Narrow band dips are accepted.

3 Nominal Beamwidth: Design angle for the -6 dB SPL points, referenced to 0 dB SPL as the highest level.

PERFORMANCE GRAPHS

PHASE LINEARITY

MKD1294

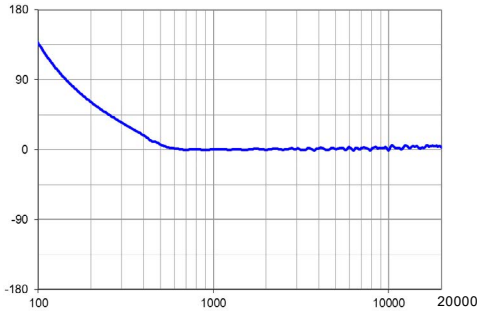

MKD1264

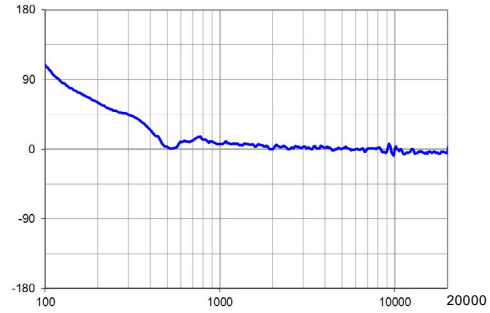

BEAMWIDTH ■=Vertical ■=Horizontal

MKD1294

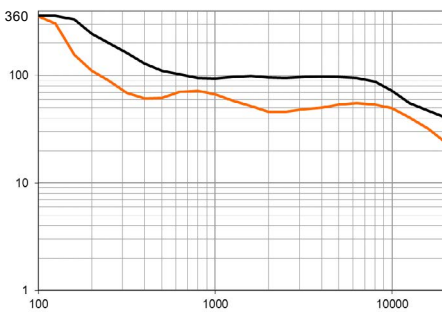

MKD1264

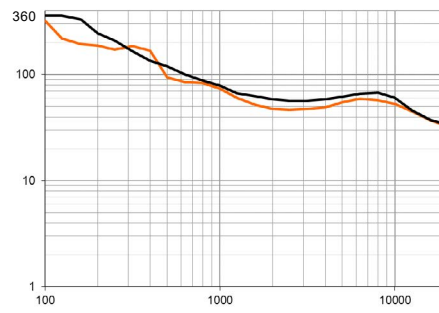

FREQUENCY ■=LF Processed ■=HF Processed ■=Overall Response Processed

MKD1294

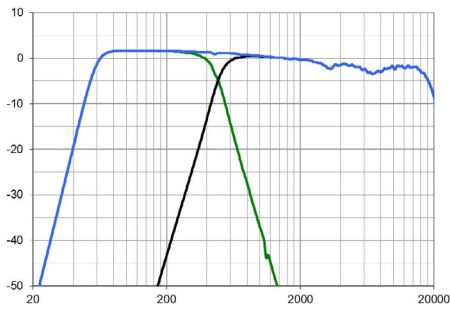

MKD1264

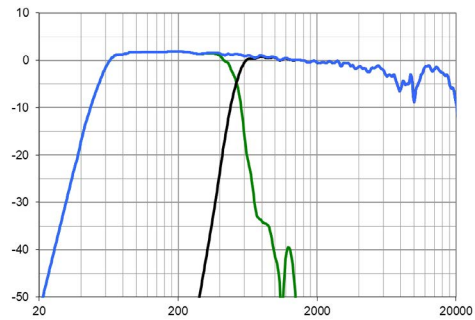

One Main Street
Whitinsville, MA 01588
Tel 800 992 5013 / +1 508 234 6158

www.eaw.com

